

Ix230 V, 50Hz, IEC38	PI [W]	I [A]
Auto min.	25	0,25
Auto max.	300	1,8
Speed I-4	180-300	1,0-1,8

TF 110 - CEN 335 - 2 - 5I	+15°C	+110°C
Temperature Range		
Water temp. max. [°C]	110	90
Ambient temp. max. [°C]	30	40
NPSH (bar)	80°C - 0,5	95°C - 1,2
Kg (netto)	12,8	

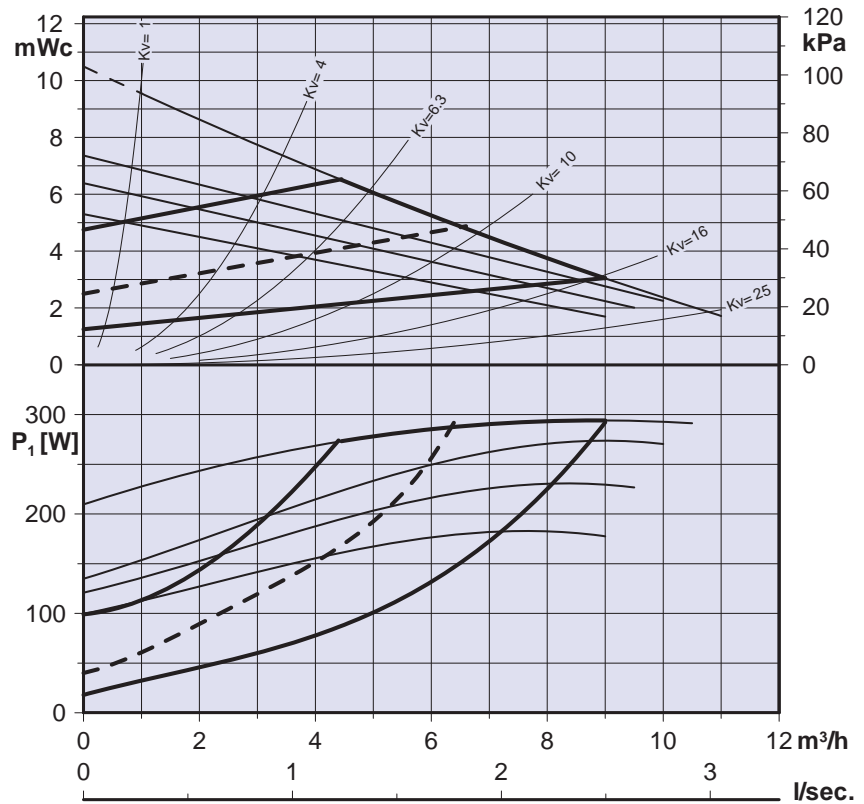
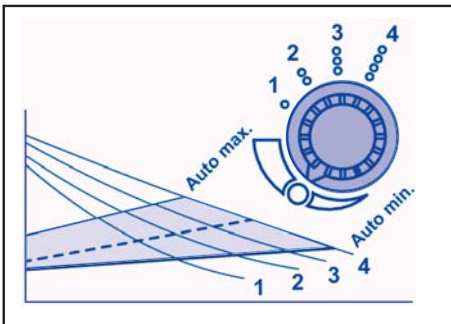

Model C = Heating / Heizung / Varme
 Model Z = Casing / Gehäuse / Pumpehus (Bronze)
 Model CD = Twin Pump / Doppelpumpe

Electrical connection

